



(12) **United States Design Patent**
Hanan

(10) **Patent No.:** **US D755,636 S**
(45) **Date of Patent:** **** May 10, 2016**

(54) **SHORT SWIRL BELL BOTTLE WITH STRAIGHT RIBS**

(71) Applicant: **Jay Clarke Hanan**, Ontario, CA (US)

(72) Inventor: **Jay Clarke Hanan**, Ontario, CA (US)

(73) Assignee: **Niagara Bottling, LLC**, Ontario (CA)

(**) Term: **14 Years**

(21) Appl. No.: **29/496,388**

(22) Filed: **Jul. 11, 2014**

(51) **LOC (10) Cl.** **09-01**

(52) **U.S. Cl.**
USPC **D9/552**; D9/414; D9/516; D9/520;
D9/549; D9/556; D9/557; D9/559; D9/569;
D9/570; D9/571; D9/574

(58) **Field of Classification Search**

USPC D3/202, 203.2, 901; D4/116; D7/313,
D7/509-511, 590-560, 601-612, 619.1,
D7/523, 525, 528, 529, 630; D9/535, 536,
D9/537, 538, 546, 552, 556, 565, 414, 516,
D9/520, 549, 557, 559, 569, 570, 571,
D9/574; D19/93; D23/211.1-211.2, 366;
D24/121, 124, 197, 224; D28/4, 7, 20,
D28/66, 76, 82, 83, 85, 88, 89, 91.1;
D6/515, 518, 522, 523, 535, 541, 542;
426/115; 215/62.22, 220, 283-285,
215/329, 396, 398, 381-384; 220/637, 674,
220/710, 837, 600, 609, 660, 669, 672,
220/675; 222/182, 209, 252; 1/1
CPC A45D 33/033; A45D 33/22; A45D 34/00;
A45D 40/30; A61J 1/03; A61J 1/05; A47G
19/22; A47G 19/2205; A47G 19/2266;
B65D 1/02; B65D 1/0223; B65D 1/08;
B65D 1/10

See application file for complete search history.

(56) **References Cited**

U.S. PATENT DOCUMENTS

D386,088 S * 11/1997 Satoh D9/536
5,927,499 A * 7/1999 Vesborg B65D 1/0292
206/509

(Continued)

FOREIGN PATENT DOCUMENTS

CN 303213727 * 5/2015
RU 00079277 * 8/2011

OTHER PUBLICATIONS

Crystal Geysler 8 oz. Bottled Water: Announced Dec. 17, 2013
[online], site visited [Sep. 1, 2015]. Available from Internet URL:
<http://www.webrestaurantstore.com/crystal-geyser-8-oz-natural-spring-bottled-water-28-cs/103WATER288.html>.*

(Continued)

Primary Examiner — Thomas Johannes
Assistant Examiner — Catherine Posthauer
(74) *Attorney, Agent, or Firm* — Rutan & Tucker, LLP; Hani Z. Sayed

(57) **CLAIM**

The ornamental design for an short swirl bell bottle with straight ribs, as shown and described.

DESCRIPTION

FIG. 1 is a bottom, front, left side, perspective view of the present invention;
FIG. 2 is front elevation view;
FIG. 3 is a rear elevation view;
FIG. 4 is a left side elevation view;
FIG. 5 is a right side elevation view;
FIG. 6 is a top plan view; and,
FIG. 7 is a bottom plan view.

1 Claim, 3 Drawing Sheets

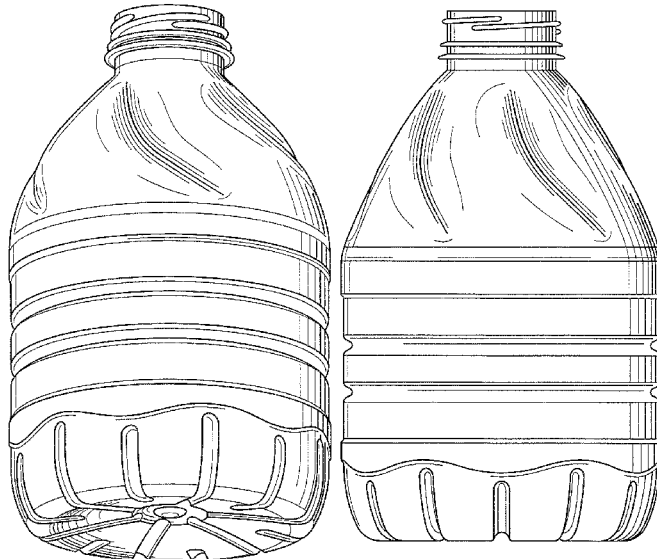

(56)

References Cited

U.S. PATENT DOCUMENTS

7,296,701 B2* 11/2007 Ozawa B65D 1/0223
 215/381
 D607,733 S * 1/2010 Lepoitevin D9/520
 D629,304 S * 12/2010 El Aquah D9/520
 D646,980 S * 10/2011 Inoi D9/552
 D657,683 S * 4/2012 Oommen D9/520
 D671,007 S * 11/2012 Lovelace, Jr. D9/516
 D709,377 S * 7/2014 Kondo D9/520
 9,120,589 B2* 9/2015 Hanan B65D 1/0223
 2011/0127279 A1* 6/2011 Oshino B65D 1/0292
 220/673

2013/0206719 A1* 8/2013 Tanaka B65D 90/36
 215/381
 2015/0144587 A1* 5/2015 Hanan B65D 1/0284
 215/377

OTHER PUBLICATIONS

Mountain Dew 12 Oz. Mini Bottles: Announced Apr. 3, 2014
 [online], site visited [Sep. 3, 2015]. Available from Internet URL:
<http://www.mtndewkid.com/mountain-dew/mountain-dew-12oz-mini-bottles/>.*

* cited by examiner

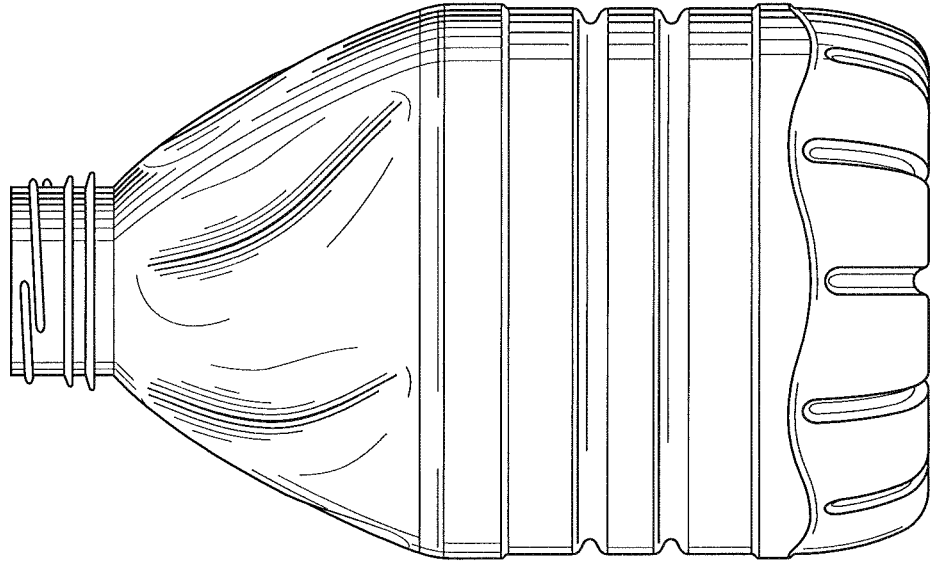

FIG. 1

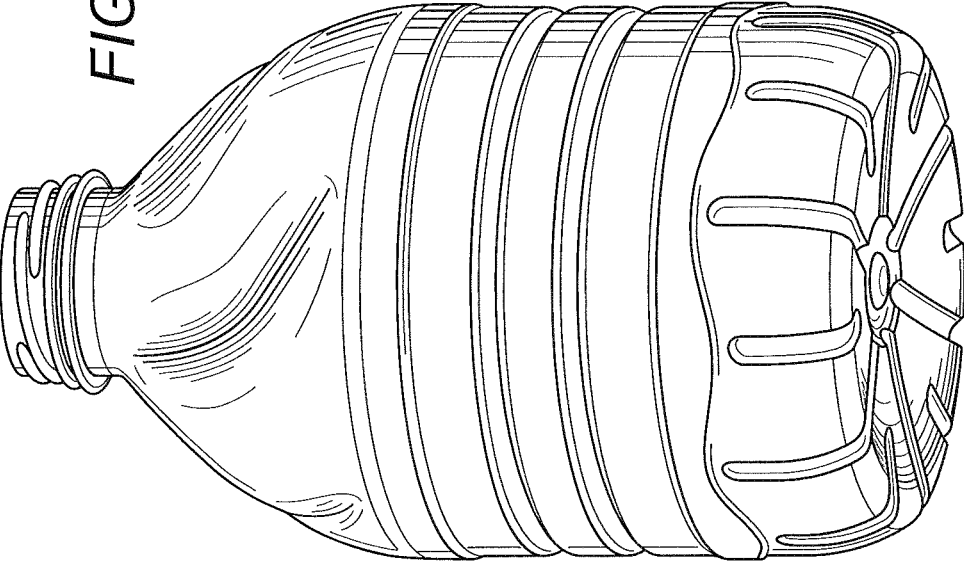

FIG. 2

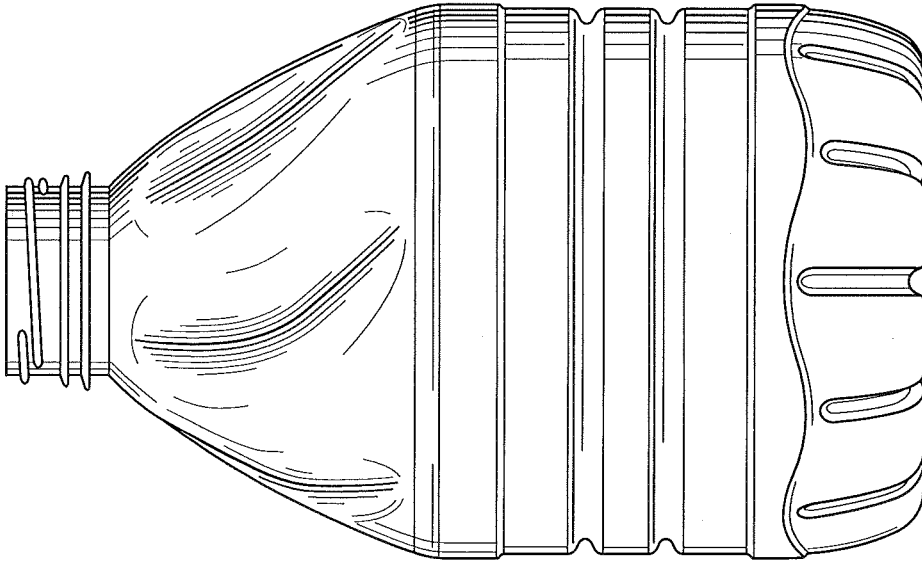

FIG. 4

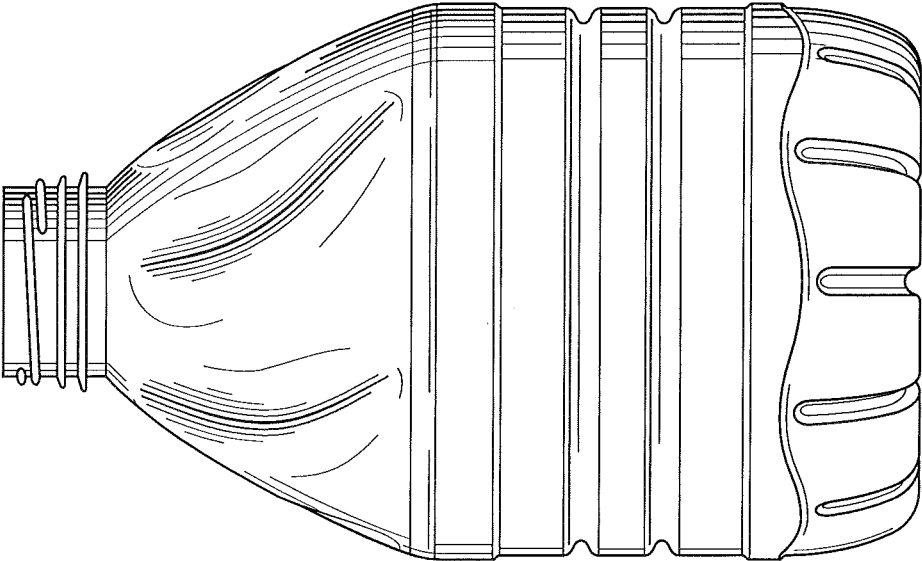

FIG. 3

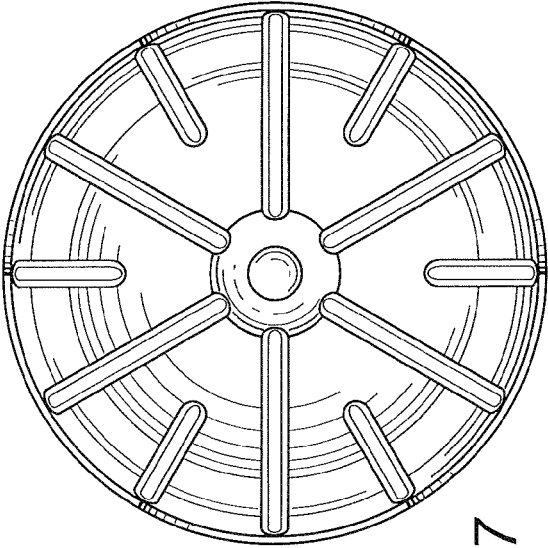
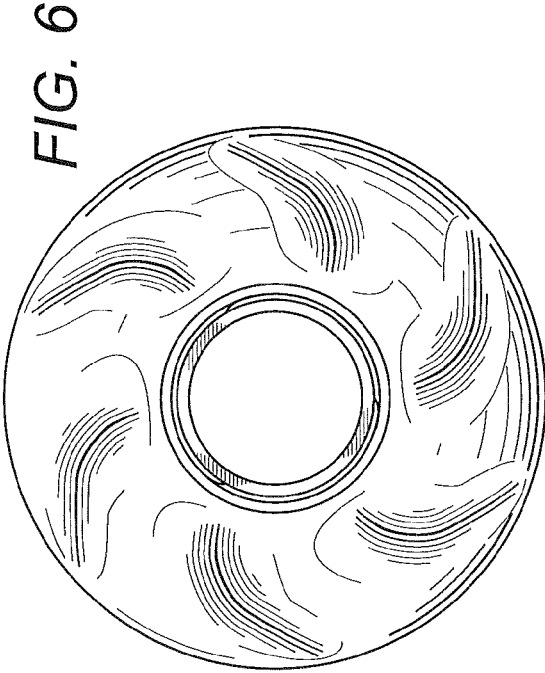

FIG. 7

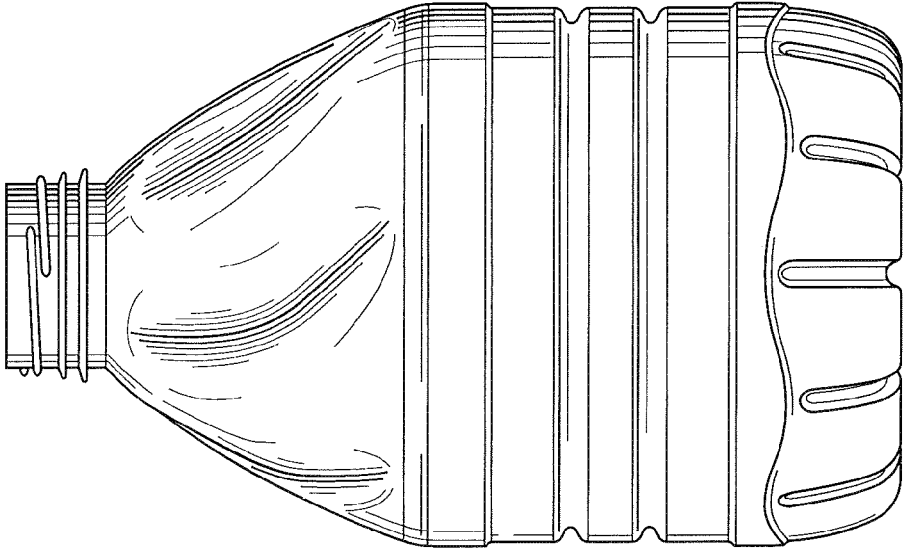

FIG. 5