



Office de la propriété
intellectuelle
du Canada

Un organisme
d'Industrie Canada

Canadian
Intellectual Property
Office

An Agency of
Industry Canada

Dessin industriel

Industrial Design

Certificat d'enregistrement

Certificate of Registration

Je certifie par la présente que le dessin identifié ci-dessous et représenté en annexe a été dûment enregistré conformément à la Loi sur les dessins industriels.

I hereby certify that the industrial design identified below and annexed hereto has been duly registered in accordance with the Industrial Design Act.

L'enregistrement est valide pour dix années, à compter de la date d'enregistrement inscrite ci-dessous, à condition que le droit de maintien ait été acquité.

The registration is valid for ten years from the registration date indicated below, subject to payment of the prescribed maintenance fee.

No d'enregistrement / Registration No. :

163503

Date d'enregistrement / Registration date :

09 mar/Mar 2016

Propriétaire / Proprietor :

NIAGARA BOTTLING, LLC
2560 E. PHILADELPHIA STREET, ONTARIO
CALIFORNIA, UNITED STATES OF AMERICA
91761

Membre du personnel du bureau du commissaire aux brevets
Officer of the Office of the Commissioner of Patents

Certificat délivré le / Certificate issued:

09 mar/Mar 2016

Canada

(CIPO 00200)
09-15

OPIC  CIPO

**DEMANDE D'ENREGISTREMENT
D'UN DESSIN INDUSTRIEL**

**APPLICATION FOR REGISTRATION
OF AN INDUSTRIAL DESIGN**

Le demandeur,

The applicant, NIAGARA BOTTLING, LLC

dont l'adresse complète est ,
whose complete address is

2560 E. PHILADELPHIA STREET, ONTARIO, CALIFORNIA, UNITED STATES OF AMERICA, 91761

demande l'enregistrement d'un dessin pour un(e)

hereby requests registration of a design for a(n) LIGHTWEIGHT ERGONOMIC ONE-PIECE CLOSURE

dont il est le propriétaire.

of which the applicant is the proprietor.

À la connaissance du propriétaire, personne d'autre que le premier propriétaire du dessin n'en faisait usage
lorsque celui-ci en a fait le choix.

The design was not, to the proprietor's knowledge, in use by any person other than the first proprietor at the
time the design was adopted by the first proprietor.

Description du dessin:

Description of the design:

The Industrial Design consists of the features of shape, pattern, ornament and configuration of the lightweight
ergonomic one-piece closure shown in the drawings.

Drawing(s)/photograph(s) of the design is (are) included.

Fig. 1 is a top, front, left side, perspective view of the lightweight ergonomic one-piece closure illustrating the
present design;

Fig. 2 is a top elevation view of the lightweight ergonomic one-piece closure as shown in Fig. 1;

Fig. 3 is a right side elevation view of the lightweight ergonomic one-piece closure as shown in Fig. 1;

Fig. 4 is a bottom elevation view of the lightweight ergonomic one-piece closure as shown in Fig. 1;

Fig. 5 is a cross-sectional view of the lightweight ergonomic one-piece closure, taken along the line A-A shown
in Fig. 2; and

Fig. 6 is a bottom, inside plan view of the lightweight ergonomic one-piece closure as shown in Fig. 1.

**A remplir seulement si le demandeur a un mandataire/
To be completed only if an applicant has an agent**

Nom du mandataire / Name of Agent :
OSLER, HOSKIN & HARCOURT LLP

Adresse complète / Complete address :
**SUITE 1900, 340 ALBERT STREET, OTTAWA
ONTARIO, CANADA
K1R 7Y6**

**Lorsque le demandeur n'a pas d'établissement au Canada, le nom et l'adresse de son
REPRÉSENTANT AUX FINS DE SIGNIFICATION au Canada doivent être indiqués.**

**If an applicant has no place of business in Canada, the name and address of a REPRESENTATIVE
FOR SERVICE in Canada must be provided.**

Nom du représentant aux fins de signification / Name of representative for service :
OSLER, HOSKIN & HARCOURT LLP

Adresse au Canada du représentant aux fins de signification / Address in Canada of representative for
service :
**SUITE 1900, 340 ALBERT STREET , OTTAWA
ONTARIO, CANADA
K1R 7Y6**

1/4

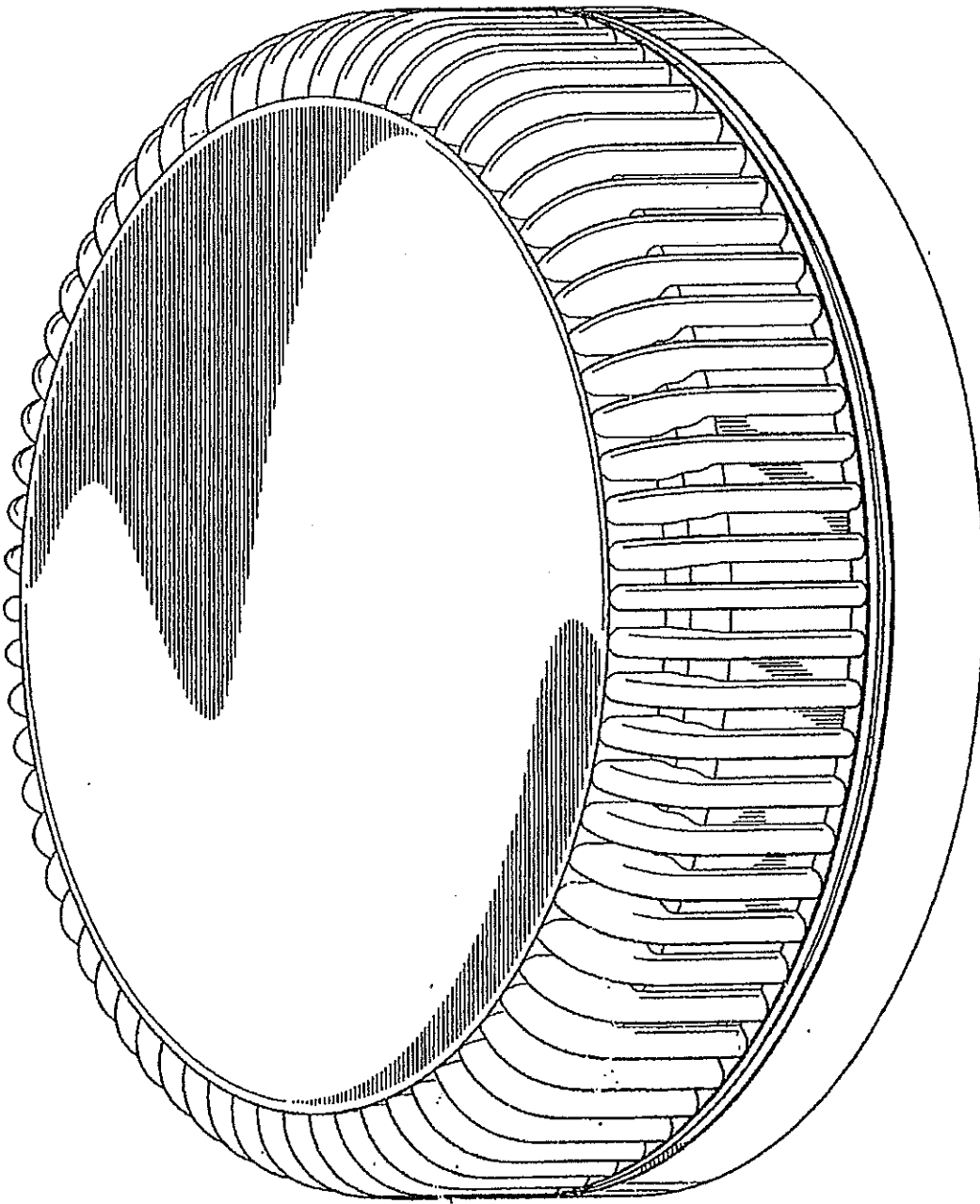

FIG. 1

2/4

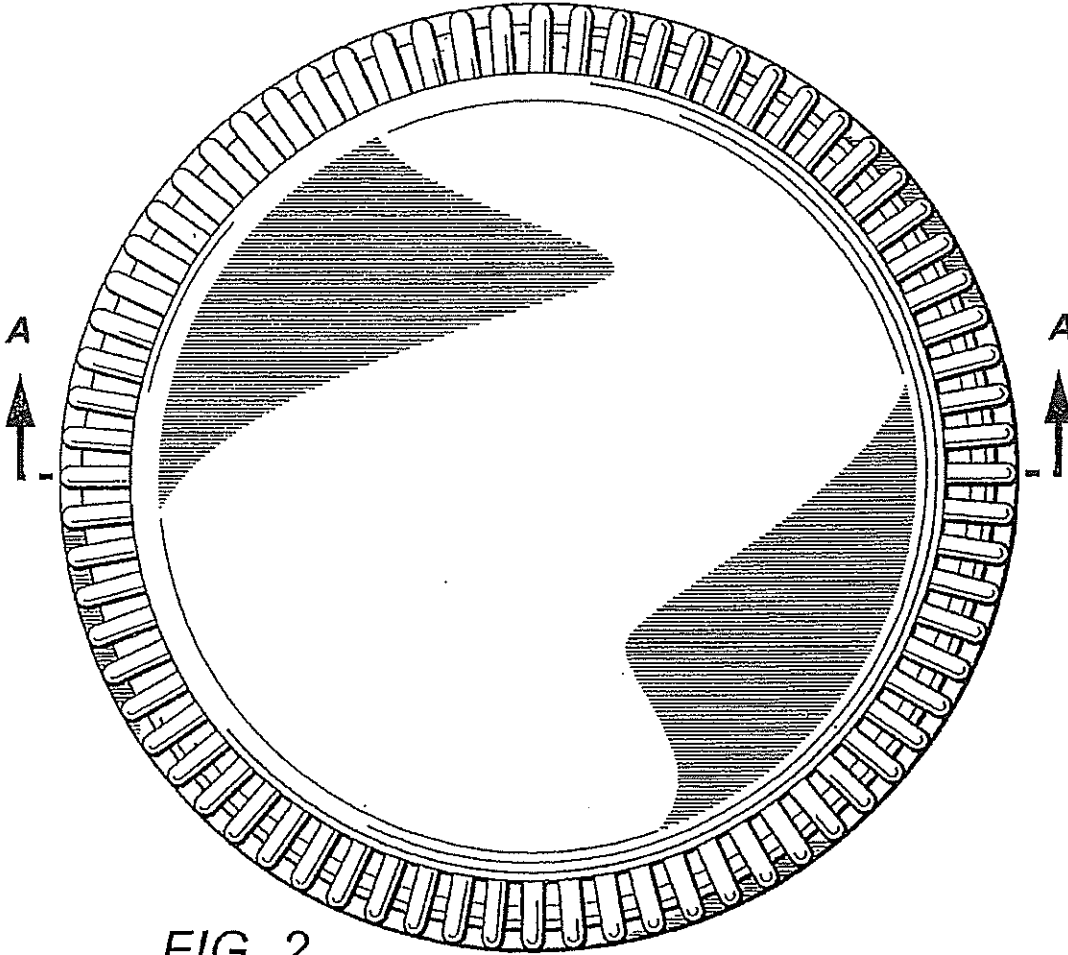
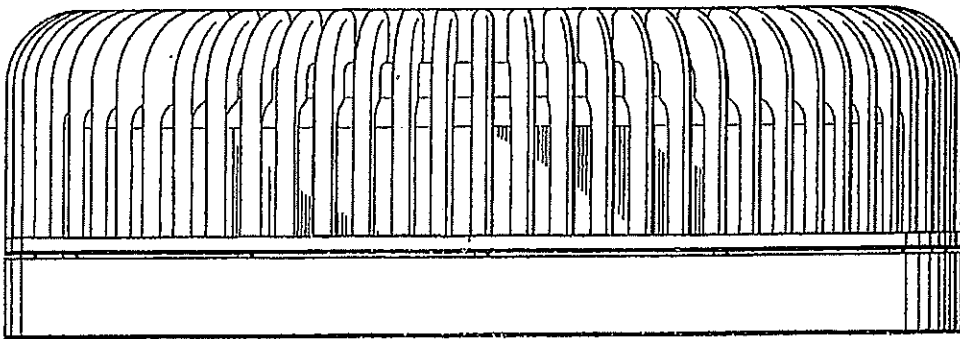

FIG. 2

FIG. 3



3/4

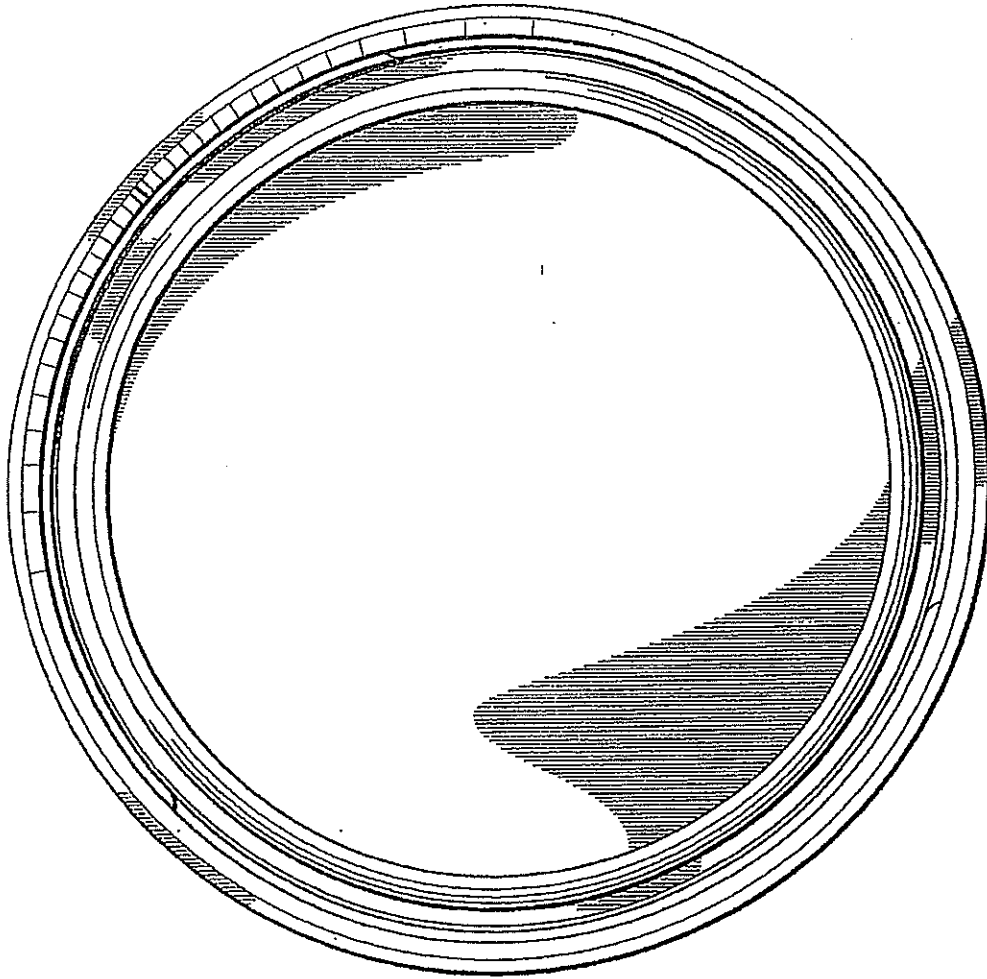
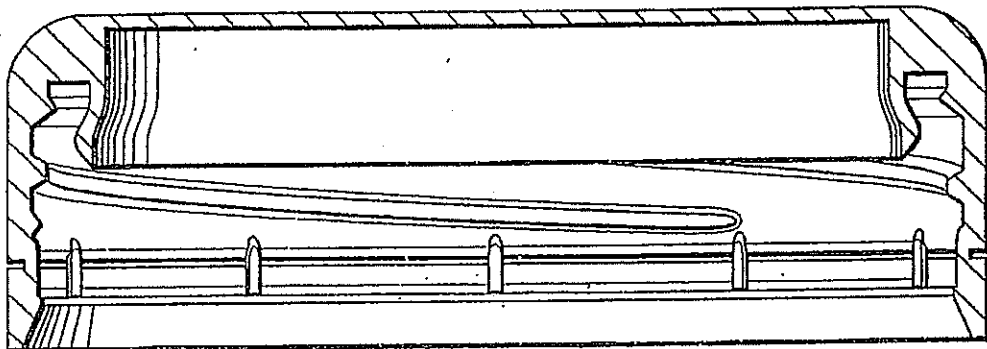

FIG. 4

FIG. 5



4/4

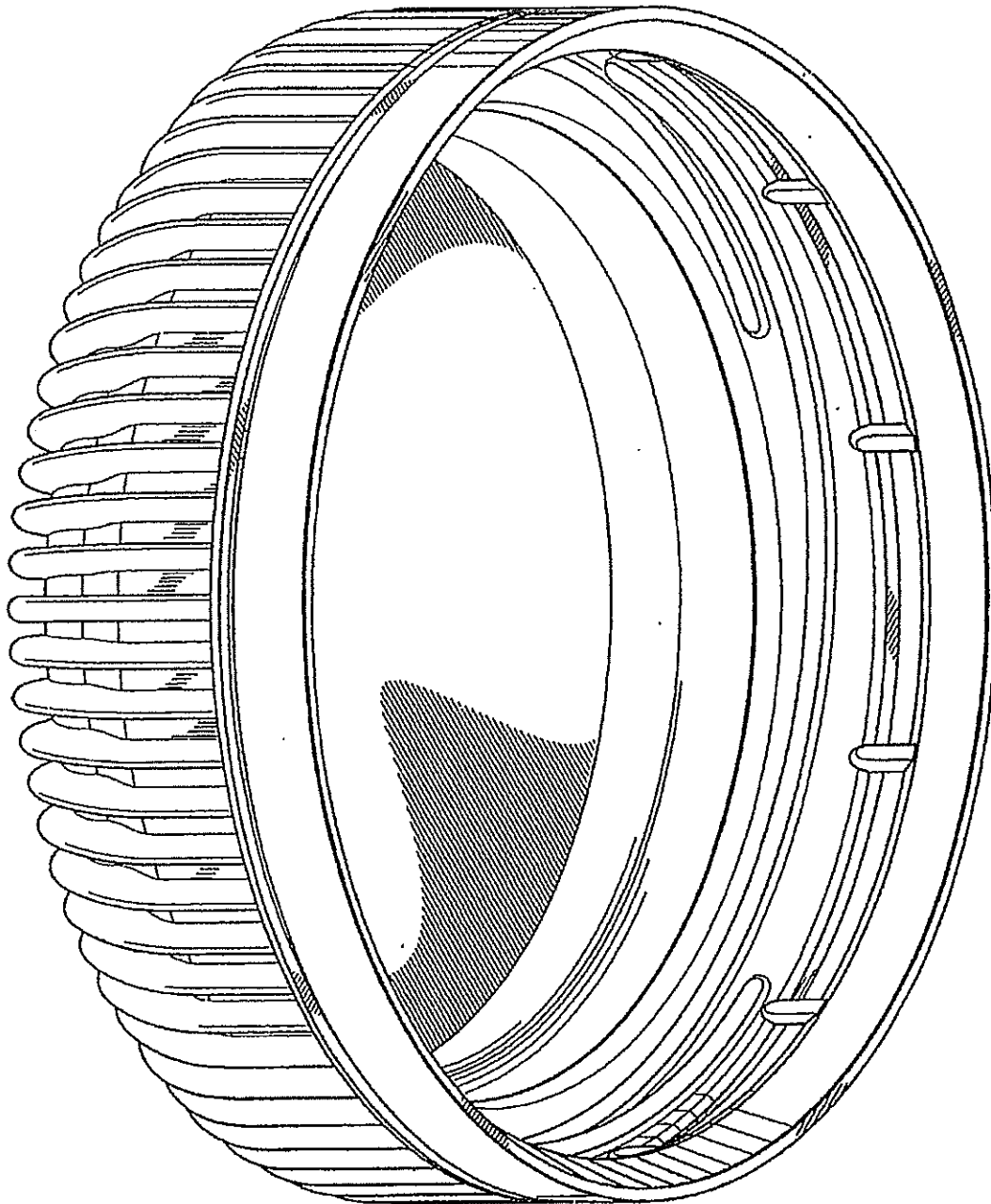

FIG. 6

Title: LIGHTWEIGHT ERGONOMIC ONE-PIECE CLOSURE

Canadian Classification:

Registered Proprietor(s): NIAGARA BOTTLING, LLC

244

Current Owner(s): NIAGARA BOTTLING, LLC

Other Classes Searched:

Client Reference Number: DCAD1753

235

Agent: OSLER, HOSKIN & HARCOURT LLP

References Considered:

Representative for Service: OSLER, HOSKIN & HARCOURT LLP

Canadian Industrial Design Registrations

Court Order(s): N/A

<u>Registration</u>	<u>Date</u>	<u>Title</u>
---------------------	-------------	--------------

Certificate of Correction: No

Other Publications:

Term of Protection: 10 years

** Subject to payment of a maintenance fee

* = Cited by Examiner

Maintenance Fee Paid: No

Filing Date: 22/07/2015

Convention Priority Claim(s):

Country	Filing Date	Application No.
UNITED STATES OF AMERICA	22/01/2015	29/515,431

Description:

The Industrial Design consists of the features of shape, pattern, ornament and configuration of the lightweight ergonomic one-piece closure shown in the drawings.

Drawing(s)/photograph(s) of the design is (are) included.

Fig. 1 is a top, front, left side, perspective view of the lightweight ergonomic one-piece closure illustrating the present design;

Fig. 2 is a top elevation view of the lightweight ergonomic one-piece closure as shown in Fig. 1;

Fig. 3 is a right side elevation view of the lightweight ergonomic one-piece closure as shown in Fig. 1;

Fig. 4 is a bottom elevation view of the lightweight ergonomic one-piece closure as shown in Fig. 1;

Fig. 5 is a cross-sectional view of the lightweight ergonomic one-piece closure, taken along the line A-A shown in Fig. 2; and

Fig. 6 is a bottom, inside plan view of the lightweight ergonomic one-piece closure as shown in Fig. 1.

Correction(s): N/A

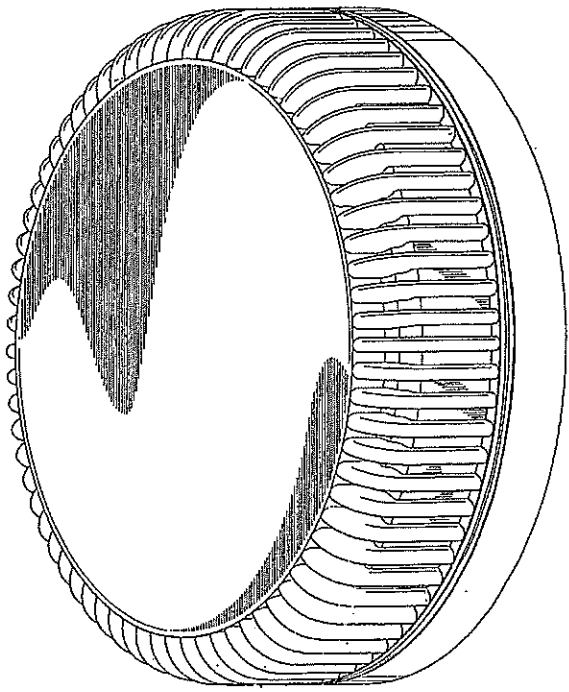

FIG. 1

AVIS AUX PROPRIÉTAIRES DES DESSINS INDUSTRIELS

Cet enregistrement de dessin industriel est valide jusqu'au 09 mars 2021.

N'importe quand avant cette date vous pouvez demander le maintien du dessin pour une période supplémentaire de cinq ans. Les frais de maintien sont prévus à *l'Annexe 2 : Tarif des droits du Règlement sur les dessins industriels*.

Un délai de six mois à partir de la date mentionnée ci-haut est possible pendant lequel on peut encore demander le maintien du dessin. Toutefois, un droit supplémentaire prévu à *l'Annexe 2 : Tarif des droits du Règlement sur les dessins industriels* doit accompagner le paiement.

Une fois que la période "de grâce" de six mois est écoulée, le droit d'exclusivité ne peut plus être maintenu. Dès lors, le dessin fera partie du domaine public.

Afin de maintenir un dessin industriel, une demande par écrit ainsi que le frais complet, en monnaie canadienne, doivent parvenir au Bureau des dessins industriels par ou avant la date d'échéance.

NOTICE TO REGISTRANTS OF INDUSTRIAL DESIGNS

This design registration is valid until March 09, 2021.

At any time prior to that date you may request that the design be maintained for a further five years. The maintenance fees are as prescribed by *Schedule 2: Tariff of Fees of the Industrial Design Regulations*.

A six-month "grace period" is allowed. A request for maintenance made after the date noted above but within six months of that date requires an additional amount as prescribed by *Schedule 2: Tariff of Fees of the Industrial Design Regulations*.

Once the six-month "grace period" has elapsed, the design can no longer be maintained and the term of exclusive right ends. From then on, the design would be in the public domain.

To maintain a design, a written request along with the full fee, in Canadian dollars, must be received in the Industrial Design Office on or before the due date.